

MCU LGT_LINK

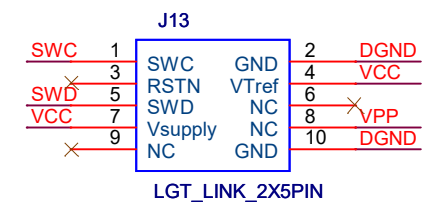

PORT RSTN

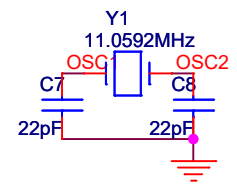
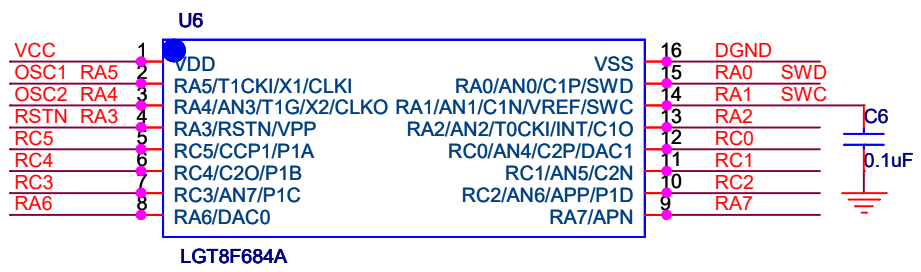
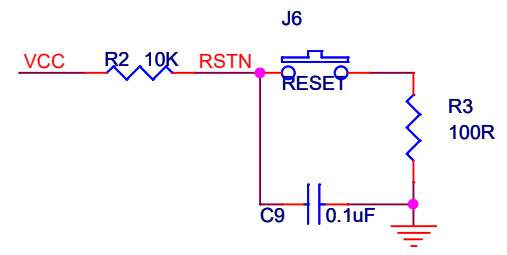
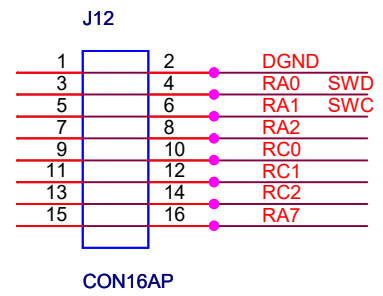
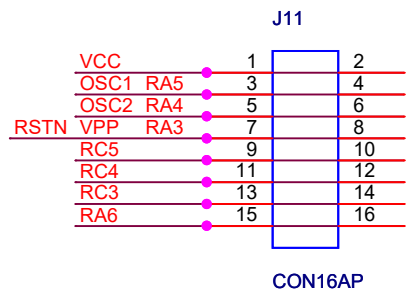

POWER

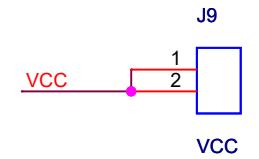
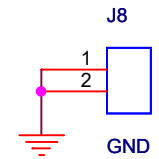
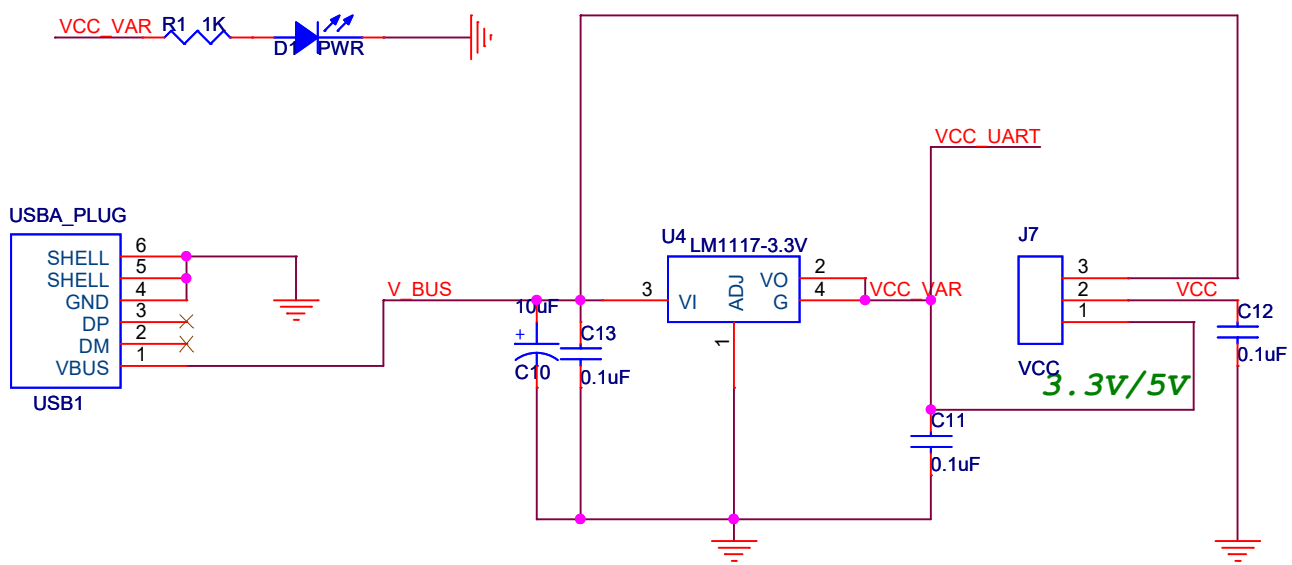

LGT www.lgtic.com

Title: SN0181_LGT8F684A_SOP16_MINI_BOARD_V1_20151009

Size A	Document Number <Doc>	Rev v1.0
--------	-----------------------	----------

Date: Thursday, October 29, 2015 Sheet 1 of 1